

# Optimal Coordination of Platoons of Connected and Automated Vehicles at Signal-Free Intersections

Sharmila Devi Kumaravel , *Student Member, IEEE*, Andreas A. Malikopoulos , *Senior Member, IEEE*, and Ramakalyan Ayyagari , *Senior Member, IEEE*

**Abstract**—In this paper, we address the problem of coordinating platoons of connected and automated vehicles crossing a signal-free intersection. We present a decentralized, two-level optimal framework to coordinate the platoons with the objective to minimize travel delay and fuel consumption of every platoon crossing the intersection. At the upper-level, each platoon leader derives a proven optimal schedule to enter the intersection. At the low-level, the platoon leader derives their optimal control input (acceleration/deceleration) for the optimal schedule derived in the upper-level. We validate the effectiveness of the proposed framework in simulation and show significant improvements both in travel delay and fuel consumption compared to the baseline scenarios where platoons enter the intersection based on first-come-first-serve and longest queue first - maximum weight matching scheduling algorithms.

**Index Terms**—Platoons coordination, intersection control, connected and automated vehicles.

## I. INTRODUCTION

### A. Motivation

**T**RAFFIC congestion has become a severe issue in urban transportation networks across the globe. Transportation networks will account for nearly 70% of travel in the world with more than 3 billion vehicles by 2050 [1]. The exponential growth in the number of vehicles and rapid urbanization have contributed to the steadily increasing problem of traffic congestion. The drivers lose 97 hours due to congestion and the cost of congestion was estimated to be \$87 billion a year, i.e., an average of \$1348 per driver in US [2]. Urban intersections in conjunction with the driver's response to various disturbances can aggravate congestion. Efficient intersection control algorithms can improve mobility, safety and alleviate the severity of congestion and accidents. Recent advancements in vehicle-to-infrastructure

and vehicle-to-vehicle (V2V) communication provide promising opportunities for control algorithms to reduce delay, travel time, fuel consumption, and emissions of vehicles [3]. The advent of connected and automated vehicles (CAVs) along with communication technologies can enhance urban mobility with better options to travel efficiently [4]. Moreover, real-time information from CAVs related to their position, speed and acceleration through on-board sensors and V2V communication makes it possible to develop effective control algorithms for coordinating CAVs aimed at improving mobility and alleviate congestion.

### B. Related Work

Several research efforts have proposed centralized and decentralized control algorithms for coordinating CAVs at intersections. Dresner and Stone [5] presented a reservation scheme as an alternative approach to traffic lights for coordinating CAVs at an intersection. Following this effort, several centralized approaches have been reported in the literature to coordinate CAVs at signal-free intersections and other traffic scenarios, e.g., merging roadways [6]–[12]. Recently, Hart *et al.* [13] developed an intersection control algorithm that considers safety and parametric uncertainties. Other research efforts in the literature have proposed decentralized control algorithms for coordinating vehicles at signal-free intersections. Wu *et al.* [14] proposed a decentralized control algorithm based on the estimated arrival time of CAVs at an intersection without eliminating stop-and-go driving. To eliminate stop-and-go driving and minimize energy consumption, a decentralized optimal control framework was presented to coordinate CAVs at an intersection and for a corridor with different transportation scenarios [15]–[18].

The road capacity and operational efficiency of the intersection can be increased significantly if the vehicles cross the intersection as platoons instead of crossing one after the other [19]. Prior to this, various research efforts in the literature address vehicle platooning at highways to increase fuel efficiency, traffic flow, comfort of driver, and safety. Bergenhem *et al.* [20] presented a detailed discussion on various research efforts in vehicle platooning systems at highways. Vehicle platooning is not only beneficial at highways but also at urban traffic intersections. Several research efforts have presented control algorithms in the literature to coordinate platoons at intersections. Jin *et al.* [21] presented an intersection management under a multiagent framework in which the platoon leaders send the

Manuscript received October 1, 2020; revised March 26, 2021; accepted July 8, 2021. Date of publication July 14, 2021; date of current version July 12, 2022. This work was supported in part by National Institute of Technology, Tiruchirappalli, India, in part by ARPAA's NEXTCAR program under the Award number DE-AR0000796 and by the Delaware Energy Institute (DEI). (Corresponding author: Sharmila Devi Kumaravel.)

Sharmila Devi Kumaravel and Ramakalyan Ayyagari are with the Department of Instrumentation and Control Engineering, National Institute of Technology, Tiruchirappalli 620015, India (e-mail: info2sj@gmail.com; rkalyan@gmail.com).

Andreas A. Malikopoulos is with the Department of Mechanical Engineering, University of Delaware, Newark, DE 19716 USA (e-mail: andreas@udel.edu).

Color versions of one or more figures in this article are available at <https://doi.org/10.1109/TIV.2021.3096993>.

Digital Object Identifier 10.1109/TIV.2021.3096993

arrival time of vehicles and request to cross the intersection based on first-come-first-serve (FCFS) policy. A hierarchical intersection management system was presented in [22] with the objective to minimize cumulative travel time and energy usage. The research effort in [23] proposed polynomial time algorithms to find schedules for the intersection with two-way traffic. Bashiri and Fleming [24] presented a control algorithm that performed an extensive search among  $n!$  schedules (which shoot up exponentially) to find a schedule with minimum average delay for  $n$  platoons. Later, a greedy algorithm was presented in [25] to find the best schedule from all possible schedules that minimizes the total delay. The research efforts in the literature developed rule based control algorithm [26], nonlinear control algorithm [27], and polling based control algorithm [28] for CAVs to gain access into the intersection.

Recently, Feng *et al.* [29] presented a reinforcement learning based control algorithm to plan the trajectories of platoons with the objective to maximize the throughput of signalized intersections. In order to completely acquire the benefits of vehicle platooning at the intersections, effective scheduling and planning of the platoons are very essential. Scheduling theory can offer effective solutions to schedule the platoons at intersections. Various techniques in scheduling theory efficiently allocate limited resources to several tasks to optimize the performance measures. Scheduling theory based control algorithm is presented in [30] to coordinate vehicles in the urban roads. Li *et al.* [31] presented a safe driving for vehicle pairs to avoid collisions at the intersections. Schedule-driven control algorithms have been reported in the literature to evacuate all vehicles in minimum time at an intersection [32] and for multiple intersections [33]. A least restrictive supervisor was designed in [34] and [35] to determine set of control actions for the vehicles to safely cross the intersection. The research effort in [36] derived the optimal schedule for CAVs and presented a closed-form analytical solution to derive optimal control input for vehicles at intersections.

Our proposed approach aims to overcome the limitations of existing approaches in the literature in the following ways:

- 1) The majority of the papers in the literature have proposed approaches for coordinating CAVs to cross the intersection one after another rather than platoons. The communication burden is significantly reduced when an intersection manager communicates only with the platoon leader instead of communicating with every CAV. Moreover, the capacity of the intersection significantly increases by vehicle platooning than allowing them to pass one after another.
- 2) Most research efforts have employed a centralized approach for coordinating platoons of CAVs at an intersection. The approach is centralized if there is at least one task in the system that is globally decided for all vehicles by a single central controller. The decision that includes all vehicles will typically result in high communication and computational load. Furthermore, centralized approaches are ineffectual in handling single point failures. On the other hand, decentralized approach reduces the communication requirements and are computationally efficient.

We present a decentralized control framework for coordinating platoons of CAVs where each platoon leader communicates

with other platoon leaders and a coordinator to derive the optimal schedule to cross the intersection. Furthermore, each platoon leader derives its optimal control input to cross the intersection while minimizing travel delay and fuel consumption.

### C. Contributions of the Paper

The main contributions of the paper are the following. We present a decentralized, two-level optimal control framework to coordinate the platoons at an intersection. In the upper-level, we propose a proven optimal framework where each platoon computes the optimal schedule to minimize the travel delay of platoons. In the low-level, we present a closed-form analytical solution that provides the optimal control input to minimize fuel consumption of vehicles.

### D. Organization of the Paper

The paper is organized as follows. In Section II, we formulate the problem, introduce the modeling framework, and present the upper-level framework that provides the optimal schedule for platoons. In Section III, we provide a closed-form, analytical solution of the low-level optimal control problem. In Section IV, we validate the effectiveness of the proposed optimal framework using VISSIM-MATLAB environment and present the simulation results. We conclude and discuss the potential directions for future work in Section V.

## II. PROBLEM FORMULATION

We consider a signal-free traffic intersection (Fig. 1) for coordinating platoons of CAVs with minimum travel delay. The region at the center of the intersection is called *merging zone*, which is the conflict area where potential lateral collisions of CAVs are possible. Although this is not restrictive, we consider the merging zone to be a square of side  $M$ . The intersection has a *schedule zone* and a coordinator that can communicate with the vehicles traveling inside the schedule zone. The distance from the entry point of the schedule zone until the entry point of the merging zone is  $S$ . The value of  $S$  depends on the communication range capability of the coordinator. The coordinator stores the information about the geometry and topology of the intersection. In addition, the coordinator stores the information about position, speed, acceleration/deceleration, and path of the platoons. Note that the coordinator acts as a database and does not take part in any of the decision making process. Each platoon leader can communicate with the coordinator, their followers and the other platoon leaders inside the schedule zone.

Let  $\mathcal{N}(t) = \{1, \dots, N(t)\}$ ,  $N(t) \in \mathbb{N}$ , be the queue of platoons inside the schedule zone. At the entry of the schedule zone, each platoon  $j \in \mathcal{N}(t)$  leader broadcasts the information of the platoon to the coordinator and other platoon leaders. This information is the 6-tuple  $\{n_j, N_{link}, N_{lane}, D_j, p_j, v_j\}$  in which  $n_j$  denotes the number of vehicles in the platoon,  $N_{link}$  denotes link number (link is the incoming road at the intersection),  $N_{lane}$  denotes lane number,  $D_j$  denotes routing decision,  $p_j$  denotes current position, and  $v_j$  denotes current speed of the platoon. Based on the information from the coordinator and other platoon leaders, each platoon leader derives the time to

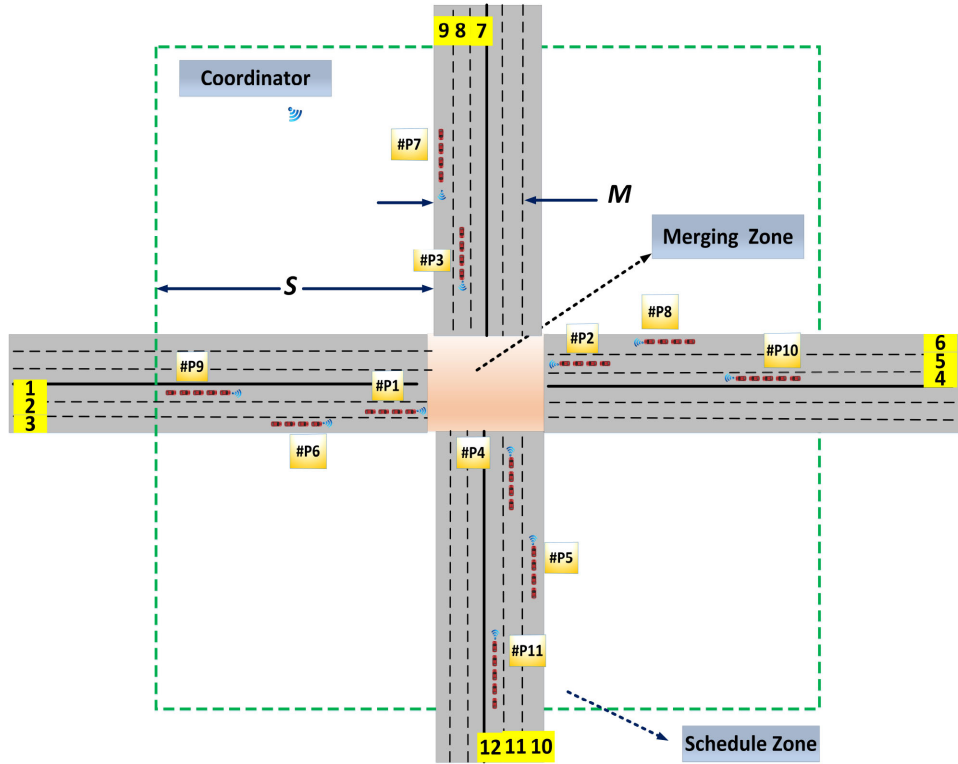

Fig. 1. A signal-free intersection with platoons of CAVs.

enter the merging zone and optimal control input to cross the intersection. Each platoon leader broadcasts the schedule and optimal control input to the followers in the platoon, and then communicates the schedule to the coordinator. The coordinator broadcasts the schedule of platoons inside the schedule zone to the leaders of the platoons entering the schedule zone.

In our modeling framework, we impose the following assumptions:

*Assumption 1:* There is no delay and communication errors between platoon leaders, the followers, and the coordinator.

The assumption may be strong, but it is relatively straightforward to relax it as long as the measurement noise and delays are bounded [37] in a statistical sense.

*Assumption 2:* The CAVs within the communication range form stable platoons, i.e., all the vehicles in the platoon move at a consensual speed and maintain the desired space between vehicles [38].

Our primary focus is to coordinate the platoons of CAVs rather than the formation and stability of platoons. However, future research should relax this assumption and investigate the implications of the proposed solution on formation and stability of platoons.

*Assumption 3:* The length of the schedule zone is sufficiently large so that a platoon can accelerate up to the speed limit and decelerate to complete stop.

We impose this assumption to ensure that the platoon entering the schedule zone with speed less than the speed limit can reach the speed limit before it enters the merging zone of the intersection. It also ensures that the platoon entering the schedule zone with a speed equal to the speed limit will have the time to

decelerate to a complete stop. We assign the maximum speed for a platoon to enter the merging zone to be equal to the speed limit.

#### A. Modeling Framework and Constraints

Let  $N(t) \in \mathbb{N}$  be the number of platoons entering into the schedule zone at time  $t \in \mathbb{R}^+$ . The coordinator assigns a unique identification number  $j \in \mathbb{N}$  to each platoon at the time they enter the schedule zone. Let  $\mathcal{N}(t) = \{1, \dots, N(t)\}$  be the queue of platoons inside the schedule zone. Let  $A_j = \{1, \dots, n_j\}$ ,  $n_j \in \mathbb{N}$ , be the number of vehicles in each platoon  $j \in \mathcal{N}(t)$ . We model each vehicle  $i \in A_j$  as a double integrator,

$$\begin{aligned} \dot{p}_i &= v_i(t), \\ \dot{v}_i &= u_i(t), \end{aligned} \quad (1)$$

where  $p_i(t) \in \mathcal{P}_i$ ,  $v_i(t) \in \mathcal{V}_i$ ,  $u_i(t) \in \mathcal{U}_i$  denote position, velocity, acceleration/deceleration. Let  $x_i(t) = [p_i(t) \ v_i(t)]^T$  denote the state of each vehicle  $i \in A_j$ . Let  $t_i^0$  be the time at which vehicle  $i \in A_j$  enters the schedule zone. Let  $x_i^0 = [p_i^0 \ v_i^0]^T$  be the initial state where  $p_i^0 = p_i(t_i^0) = 0$ , taking values in the state space  $\mathcal{X}_i = \mathcal{P}_i \times \mathcal{V}_i$ . The control input and speed of each vehicle  $i \in A_j$  is bounded with following constraints

$$u_{\min} \leq u_i(t) \leq u_{\max}, \quad (2)$$

$$0 \leq v_{\min} \leq v_i(t) \leq v_{\max}, \quad (3)$$

where  $u_{\min}, u_{\max}$  are the minimum and maximum control inputs and  $v_{\min}, v_{\max}$  are the minimum and maximum speed limits, respectively.

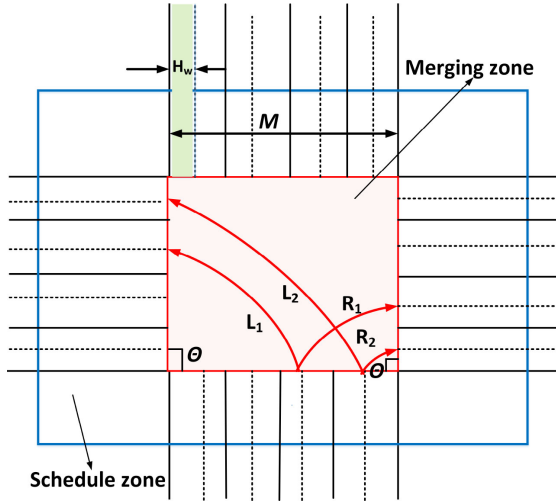

Fig. 2. Intersection layout.

### B. Modeling Left Turn and Right Turns at an Intersection

Let  $D_j$  denote the routing decision (straight/left/right) of platoon  $j$ . Here,  $D_j = S$  denotes the decision to go straight,  $D_j = L$  denotes the decision to turn left, and  $D_j = R$  denotes the decision to turn right at the intersection. We consider an intersection layout as shown in Fig. 2.

The distance covered by a turning vehicle at the intersection is

$$d = \frac{\theta}{360}(2\pi r), \quad (4)$$

where  $\theta$  is the angle subtended at the centre in radians and  $r$  is the turning radius.

Let  $W$  be number of the lanes in the road approaching the intersection. Let  $H_w$  be half of a lane i.e.,

$$H_w = \frac{\text{width of a lane}}{2} \quad (5)$$

Let  $H_r$  be the number of half lanes ( $H_w$ ) from right end of the road and  $H_l$  be the number of half lanes ( $H_w$ ) from left end of the road. The distance covered by a platoon  $j$  that goes either straight, left or right inside merging zone is

$$d_j^* = \begin{cases} M, & D_j = S, \\ 1 - \frac{H_r}{2W}\pi M, & D_j = L, \\ 1 - \frac{H_l}{2W}\pi M, & D_j = R. \end{cases} \quad (6)$$

In case of left turn  $L_1$  and right turn  $R_1$  at the intersection (Fig. 2),  $W = 4$ ,  $H_l = 5$  and  $H_r = 3$ . The distance covered by  $L_1$  and  $R_1$  are  $\frac{5}{8}\pi M$  and  $\frac{3}{8}\pi M$ , respectively. In case of left turn  $L_2$  and right turn  $R_2$  at the intersection (Fig. 2),  $W = 4$ ,  $H_l = 7$  and  $H_r = 1$ . The distance covered by  $L_2$  and  $R_2$  are  $\frac{7}{8}\pi M$  and  $\frac{1}{8}\pi M$ , respectively.

The maximum allowable speed limit  $v$  for turning vehicles [39] is

$$v = \sqrt{15R(0.1E + F)}, \quad (7)$$

where  $R$  is the effective centerline turning radius,  $E$  is the super-elevation (zero in urban conditions), and  $F$  is the side friction

factor. The maximum speed limit  $v_{\max}^l$  and  $v_{\max}^r$  of the platoons turning left and right, respectively inside merging zone are

$$v_{\max}^l = \sqrt{15R_l(0.1E + F)}, \quad (8)$$

$$v_{\max}^r = \sqrt{15R_r(0.1E + F)}, \quad (9)$$

where  $R_l$  and  $R_r$  effective centerline turning radius of left turn and right turn at the intersection, respectively. The maximum speed limit  $v_{\max}$  of the platoon that goes either straight, turning left or right inside merging zone is denoted as,

$$v_{\max} = \begin{cases} v_{\max}^s, & D_j = S, \\ v_{\max}^l, & D_j = L, \\ v_{\max}^r, & D_j = R. \end{cases} \quad (10)$$

### C. Upper-Level Optimal Framework for Coordination of Platoons

In this section, we discuss the upper-level optimization framework that yields the optimal schedule for the platoons to cross the merging zone with a minimum delay. The proposed framework is based on scheduling theory which addresses the allocation of jobs to the machines for a specified period of time aiming to optimize the performance measures. A scheduling problem is described by the following notation  $\mathcal{M}|\mathcal{C}|\mathcal{O}$ , where  $\mathcal{M}$  denotes machine environment,  $\mathcal{C}$  denotes the constraints, and  $\mathcal{O}$  denotes the objective function. We consider a job-shop scheduling problem where several jobs are processed in a single machine environment. Let  $K \in \mathbb{N}$  be the number of jobs to be processed in a single machine. Let  $t_k^p$  and  $t_k^d$  be the processing time and deadline for each job  $k \in K$ . In a machine  $\mathcal{M}$ , if a job  $k$  starts at time  $t_k^s$  and completes at time  $t_k^f$ , then the completion time of job  $k$  is  $t_k^f = t_k^s + t_k^p$ .

*Definition 1:* The lateness  $\mathcal{L}_k$  of a job  $k$  is defined as

$$\mathcal{L}_k \triangleq t_k^f - t_k^d. \quad (11)$$

The job-shop scheduling problem of minimizing maximum lateness in a single machine environment is represented as  $1||L_{\max}$  problem, where 1 denotes a single machine and  $L_{\max}$  denotes the maximum lateness. A schedule is said to optimal if it minimizes  $\max_k \mathcal{L}_k$ , i.e., the maximum lateness of jobs.

In our proposed framework, we model the intersection as a single machine and the platoons as jobs. Based on Assumption 1, the vehicles form stable platoon and each stable platoon is considered as a job. The processing time is the time taken by the job to be completed in a machine. We model the processing time of a job as *passing time* of platoons, i.e., the time taken by the platoons at the maximum speed to exit the intersection. The deadline of a job is the time before which it must be completed in a machine. We model the deadline of the job as *deadline* of the platoons, i.e., the time taken by the platoons at their initial speed to exit the intersection. Then, each platoon leader solves  $1||L_{\max}$  scheduling problem in a single machine environment (intersection) to find the optimal schedule to enter the merging zone of the intersection that minimizes maximum lateness, i.e., travel delay.



*Definition 2:* Let  $t_j^0$  and  $t_j^m$  be the time at which the platoon  $j \in \mathcal{N}(t)$  enters the schedule zone and merging zone, respectively. The arrival time period  $t_j^a$  of the platoon  $j \in \mathcal{N}(t)$  at the merging zone is

$$t_j^a \triangleq t_j^m - t_j^0. \quad (12)$$

*Definition 3:* Let  $t_j^e$  be the time at which the platoon  $j \in \mathcal{N}(t)$  exits the merging zone. The crossing time period  $t_j^c$  of a platoon  $j \in \mathcal{N}(t)$  is

$$t_j^c \triangleq t_j^e - t_j^m. \quad (13)$$

*Definition 4:* The passing time  $t_j^p$  of a platoon  $j \in \mathcal{N}(t)$  at the intersection is

$$t_j^p \triangleq t_j^a + t_j^c. \quad (14)$$

We consider two cases for computing the passing time of platoons at the time they enter the schedule zone. In Case 1, the platoon enters the schedule zone while cruising with the speed limit. In Case 2, the platoon enters the schedule zone with speed that is less than the speed limit. Let  $v_j^0 = v_j(t_j^0)$  be the initial speed of the platoon  $j \in \mathcal{N}(t)$ , i.e., speed at which the platoon enters the schedule zone. Let  $|A_j|$  be the cardinality of  $A_j$ . Let  $t_j^h$  be the time headway between the vehicles  $i$  and  $(i-1) \in A_j$  in the platoon. For instance, if there is a platoon of 4 vehicles and all moving at constant speed of 10 m/s with uniform time headway of 1.2 sec, the space headway between vehicles in a platoon is  $(10 \times 1.2) = 12$  m. Let  $t_c$  be the clearance time interval, i.e., a safe time gap provided between exit and entry of platoons at the merging zone to ensure safety of platoons.

*Case 1:*  $v_j^0 = v_{\max}$

Using  $v_{\max}$ , we compute the arrival time

$$t_j^{a*} = \frac{S}{v_{\max}}, \quad (15)$$

and the crossing time of platoons

$$t_j^{c*} = \frac{d^*}{v_{\max}} + (|A_j| - 1) \times t_j^h + t_c. \quad (16)$$

*Case 2:*  $v_j^0 < v_{\max}$

We compute  $t_j^{a*}$  using the time taken by the platoon to accelerate to the speed limit applying its maximum acceleration. Let  $t_j^s$  be the time taken by the platoon  $j$  to accelerate to the speed limit, then we have

$$t_j^s = \frac{v_{\max} - v_j^0}{u_{\max}}. \quad (17)$$

Let  $d_j^s$  be the distance traveled during acceleration, then we have

$$d_j^s = \frac{(v_{\max})^2 - (v_j^0)^2}{2u_{\max}}. \quad (18)$$

Based on Assumption 3, the platoons will reach the speed limit at time  $t \leq t_j^{a*}$  and

$$t_j^{a*} = t_j^s + \frac{S - d_j^s}{v_{\max}}, \quad (19)$$

and  $t_j^{c*}$  is computed using (16).

*Definition 5:* Let  $t_j^{a'}$  be the time taken by the platoon  $j$  to reach the merging zone while cruising with their initial speed. The deadline  $t_j^d$  of the platoon  $j$  to completely cross the intersection is defined as

$$t_j^d \triangleq t_j^{a'} + t_j^{c*}. \quad (20)$$

We compute  $t_j^{a'}$  as

$$t_j^{a'} = \frac{S}{v_j^0}, \quad (21)$$

and the crossing time  $t_j^{c*}$  of the platoon using (16).

*Definition 6:* Let  $\Gamma_i$  and  $\Gamma_j$  be the path of platoons  $i$  and  $j \in \mathcal{N}(t)$ , respectively. The platoons  $i$  and  $j$  are said to be compatible if  $\Gamma_i \cap \Gamma_j = \emptyset$ , i.e., paths of platoons  $i$  and  $j$  are non-conflicting and can be given right-of-way concurrently inside the merging zone.

The compatibility between the paths of the platoons can be modeled as a compatibility graph.

*Definition 7:* A compatibility graph  $\mathcal{G}_c = (\mathcal{V}, \mathcal{E})$  is an undirected graph where  $\mathcal{V}$  is the set of vertices and  $\mathcal{E}$  is the set of edges. The adjacency matrix  $A = [a_{ij}]$  of compatibility graph  $\mathcal{G}_c$  can be defined as

$$a_{ij} = \begin{cases} 1, & \text{if paths of platoons } i \text{ and } j \text{ do not conflict,} \\ 0, & \text{if paths of platoons } i \text{ and } j \text{ conflict.} \end{cases} \quad (22)$$

For example, we consider an intersection with traffic movements as shown in Fig. 3. In Fig. 3(a), let  $p, q$ , and  $r \in \mathcal{N}(t)$  be the platoons entering the schedule zone at time  $t$ . Here,  $\mathcal{V} = \{p, q, r\}$  is the vertex set of compatibility graph  $\mathcal{G}_c$ . An edge  $e$  connects the vertices  $\{p, q\}$ ,  $\{q, r\}$ , and  $\{p, r\}$  since their paths are non-conflicting inside the merging zone.

*Definition 8:* A clique  $\mathcal{C}$  of  $\mathcal{G}_c$  is a subset of the vertices  $\mathcal{C} \subseteq \mathcal{V}$  such that each vertex in  $\mathcal{C}$  is adjacent to all other vertices in  $\mathcal{C}$ .

*Definition 9:* A maximal clique  $\mathcal{M}$  is the clique that consists of a set of vertices  $\mathcal{M} \subseteq \mathcal{V}$  which is not a subset of any other cliques in the undirected graph  $\mathcal{G}_c$ .

In Fig. 3(a), the set of vertices  $\{p, q, r\}$  forms the maximal clique of the compatibility graph  $\mathcal{G}_c$ . In our framework, the maximal cliques represents the groups of compatible platoons that can be given right-of-way concurrently inside the merging zone. Therefore, there is one group of compatible platoons. In Fig. 3(b), The set of vertices  $\{p, q\}$  and  $\{r, s\}$  are the maximal cliques of the compatibility graph  $\mathcal{G}_c$ . Therefore, there are two groups of compatible platoons. In Fig. 3(c), The set of vertices  $\{p\}$ ,  $\{q\}$ , and  $\{s\}$  are the maximal cliques of the compatibility graph  $\mathcal{G}_c$ . Therefore, there are three groups of compatible platoon. In Fig. 3(d), The set of vertices  $\{p, q, s\}$  form the the maximal clique of the compatibility graph  $\mathcal{G}_c$ . Therefore, there is one group of compatible platoons. We generate group of compatible platoons as illustrated in Fig. 3 for various combinations of routing decisions of platoons.

*Definition 10:* Let  $G = \{1, \dots, n\}$  be the set of groups of compatible platoons. The completion time  $t_G^f$  is defined as the time taken by all groups of platoons in  $G$  to completely exit the merging zone of the intersection.

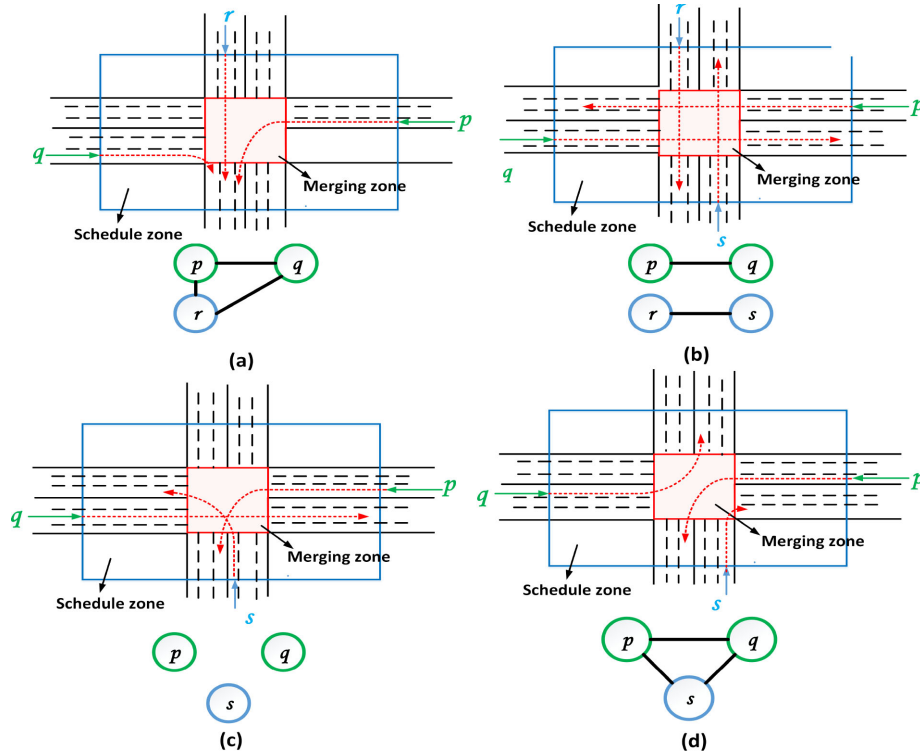

Fig. 3. Intersection with traffic movements.

In the upper-level optimization framework, we model the problem of coordinating platoons at the intersection as a job-shop scheduling problem, the solution of which yields the optimal schedule for each platoon to cross the intersection through four algorithms. The proposed framework uses the information about passing time and deadline of each platoon entering the schedule zone. Algorithm 1 computes the passing time of each platoon given the speed limit, geometric information of the intersection, and attributes  $(n_j, N_{link}, N_{lane}, D_j, p_j, v_j)$  of the platoon  $j \in \mathcal{N}(t)$ . Algorithm 2 computes the deadline of each platoon to cross the intersection. Next, Algorithm 3 categorizes the platoons into groups of compatible platoons and computes the passing time, deadline, and crossing time of each group. The earliest due date principle [40] for scheduling jobs in a single machine environment is optimal in minimizing the maximum lateness of the jobs. We adapt the earliest due date principle in Algorithm 3 to find an optimal sequence of platoons to reduce the delay. Finally, Algorithm 4 computes the time of entry for each platoon inside the merging zone. The upper-level optimal framework thus yields an optimal schedule to reduce the delay of platoons which is equivalent to  $1||L_{\max}$  scheduling problem and a proof is presented below.

**Theorem 1:** The schedule  $S$  in the non-decreasing order of deadline  $t_g^d$  of each group  $g \in G$  is optimal in minimizing the travel delay, i.e., the maximum lateness of the platoons.

**Proof:** Let  $t_g^d$  be deadline of the each group  $g \in G$  and the groups are arranged in non-decreasing order of their deadlines. Let consider two groups of platoons  $i$  and  $j$  arriving at the schedule zone at time  $t$ . Let the lateness of the platoon group  $i$  and  $j$  be  $\mathcal{L}_i$  and  $\mathcal{L}_j$ , respectively. Suppose there exists a schedule

$S'$  in which the group  $i$  enters the merging zone before the group  $j$  and  $t_i^d > t_j^d$ . Then,

$$\mathcal{L}_i^{S'} = (t + t_i^p) - t_i^d, \quad (23)$$

$$\mathcal{L}_j^{S'} = (t + t_i^p + t_j^p) - t_j^d, \quad (24)$$

which implies,

$$\mathcal{L}_j^{S'} > \mathcal{L}_i^{S'}. \quad (25)$$

Suppose there is an another schedule  $S$ , in which group  $j$  enters the merging zone before the group  $i$  at time  $t$ . Then we have

$$\mathcal{L}_j^S = (t + t_j^p) - t_j^d < \mathcal{L}_j^{S'}, \quad (26)$$

$$\mathcal{L}_i^S = (t + t_j^p + t_i^p) - t_i^d < \mathcal{L}_i^{S'}. \quad (27)$$

Thus,

$$\max\{\mathcal{L}_j^S, \mathcal{L}_i^S\} \leq \max\{\mathcal{L}_i^{S'}, \mathcal{L}_j^{S'}\}. \quad (28)$$

Thus, the schedule  $S$  is optimal if and only if the deadlines  $t_g^d$  of groups of compatible platoons have been sorted in a non-decreasing order.

The platoon leader runs the algorithm at every time step after entering the schedule zone. The platoon leaders inside the schedule zone communicate with each other and find the time they can enter the merging zone. Then, they derive their optimal control input to enter the merging zone. When a new platoon enters the schedule zone, the platoon leader along with the other platoon leaders run the algorithm to find the new schedule excluding the platoons that have entered the merging zone. After entering the merging zone, the platoon leader does not communicate to

**Algorithm 1:** Compute passing time of platoons.

---

**Input:**  $v_j^0, |A_j|, t_j^h$  of each platoon  $j$ ,  $v_{\max}, t_c, S, M, u_{\max}$ .  
**Output:**  $t_j^{a*}, t_j^{c*}$  and  $t_j^p$  of each platoon  $j$ .  
 {▷ Computation of arrival time}

- 1: **for**  $j = 1$  to  $N$  **do**
- 2: **if**  $v_{\max} = v_j^0$  **then**
- 3:  $t_j^{a*} \leftarrow S/v_{\max}$
- 4: **else if**  $v_{\max} < v_j^0$  **then**
- 5:  $t_j^s \leftarrow (v_{\max} - v_j^0)/u_{\max}$
- 6:  $d_j^s \leftarrow [(v_{\max}^2) - (v_j^0)^2]/2u_{\max}$
- 7:  $t_j^{a*} \leftarrow t_j^s + (S - d_j^s)/v_{\max}$
- 8: **end if**
- 9: **end for**
- ▷ Computation of crossing time
- 10: **for**  $j = 1$  to  $N$  **do**
- 11:  $t_j^{c*} \leftarrow d^*/v_{\max} + (|A_j| - 1) * t_j^h + t_c$
- 12: **end for**
- ▷ Computation of passing time
- 13: **for**  $j = 1$  to  $N$  **do**
- 14:  $t_j^p \leftarrow t_j^{a*} + t_j^{c*}$
- 15: **end for**

---

**Algorithm 2:** Compute deadline for platoons to exit the merging zone.

---

**Input:**  $v_j^0, t_j^{c*}$  of each platoon  $j$ ,  $S$ .  
**Output:**  $t_j^d$  of each platoon  $j$ .  
 {▷ Computation of arrival time}

- 1: **for**  $j = 1$  to  $N$  **do**
- 2:  $t_j^{a'} \leftarrow S/v_j^0$
- 3: **end for**
- {▷ Computation of deadline}
- 4: **for**  $j = 1$  to  $N$  **do**
- 5:  $t_j^d \leftarrow t_j^{a'} + t_j^{c*}$
- 6: **end for**

---

the other platoon leaders. The new platoon in the schedule zone computes its time of entry into the merging zone based on the platoons inside the schedule zone and the crossing time of the platoons that have entered the merging zone. The platoons inside the schedule zone should not enter the merging zone until the crossing platoon has completely exited the merging zone. The new platoon leaders inside the schedule zone fetch the crossing time of platoons that have entered the merging zone from the coordinator which is acting as a database.

**D. Low-Level Framework for Optimal Control Problem**

In the low-level optimization framework, each platoon derives the optimal control input based on the time of entry into the merging zone designated by the upper-level framework. The platoons enter the merging zone at the designated time and in the order of the optimal sequence provided by upper-level framework. The platoons are allowed to cross the intersection

**Algorithm 3:** Compute the groups of compatible platoons and optimal sequence.

---

**Input:** compatibility graph  $\mathcal{G}_c, t_j^p, t_j^{c*}, t_j^d$  of each Platoon  $j$ .  
**Output:** groups of compatible platoons  $G, t_g^d, t_g^p, t_g^{c*}$  of each group  $g$  and optimal sequence.

- 1:  $G \leftarrow$  maximal cliques of compatibility graph,  $\mathcal{G}_c$ .  
 {▷ Computation of passing time, crossing time and deadline of each group of platoon}
- 2: Initialize Array  $deadline \leftarrow 0$
- 3: Initialize Array  $passingTime \leftarrow 0$
- 4: Initialize Array  $exitTime \leftarrow 0$
- 5: Initialize variable  $i \leftarrow 1$
- 6: **for each**  $g$  in  $G$  **do**
- 7: **for**  $j = 1$  to  $N$  **do**
- 8: **if**  $j \in g$  **then**
- 9:  $deadline[i] \leftarrow t_j^d$
- 10:  $passingTime[i] \leftarrow t_j^p$
- 11:  $exitTime[i] \leftarrow t_j^{c*}$
- 12:  $i \leftarrow i + 1$
- 13: **end if**
- 14: **end for**
- 15:  $t_g^d \leftarrow \max(deadline)$
- 16:  $t_g^{c*} \leftarrow \max(exitTime)$
- 17:  $t_g^p \leftarrow \max(passingTime)$
- 18:  $i \leftarrow 1$
- 19: **end for**
- 20:  $optimalSequence =$  Platoon groups sorted in non-decreasing order of deadline  $t_g^d$

---

based on their position in the optimal sequence. In that case, some platoons enter the merging zone at its earliest arrival time. Other platoons inside the schedule zone have to wait for the other platoons inside the merging zone to exit the merging zone. The platoons waiting for other platoons to exit the merging zone derive energy optimal trajectory to enter the merging zone at the time specified by the upper-level optimal framework. If the time that a platoon enters inside the merging zone is equal to its earliest arrival time, then the leader derives the optimal control input by solving the time optimal control problem. If the time of entry of a platoon inside the merging zone is greater than the earliest arrival time, then the leader derives the optimal control input by solving an energy optimal control problem. After deriving the optimal control input, based on Assumption 2, each platoon leader communicates the time of entry and optimal control input (acceleration/deceleration) to the followers until the last vehicle in the platoon exit the merging zone.

1) *Time Optimal Control Problem:* For each leader  $l \in A_j$  of the platoon  $j \in \mathcal{N}(t)$ , we define the following optimal control problem

$$\min_{u_l \in \mathcal{U}_l} J_1(u_l(t)) = \int_{t_l^0}^{t_l^m} dt = t_l^m - t_l^0, \quad (29)$$

subject to: (1), (2), (3),  $p_l(t_l^0) = 0, p_l(t_l^m) = L_s$ ,  
 and given  $t_l^0, v_l^0, t_l^m$ ,

**Algorithm 4:** Compute time of entry for each platoon.

---

**Input:** current time  $t$ , optimalSequence,  $t_g^p, t_g^{c*}, t_g^d$  of each group  $g$ ,  $t_j^{a*}$  of each platoon  $j$ .  
**Output:**  $t_j^m$  of each platoon  $j$ .  
{▷ Computation of time of entry for first group in the optimal sequence}

- 1: Initialize variable  $t_G^f \leftarrow 0$
- 2:  $l = \text{optimalSequence}[1]$
- 3: **for** each  $j \in l$  **do**
- 4:    $t_j^m \leftarrow t + t_j^{a*}$
- 5: **end for**
- 6:  $t_l^e \leftarrow t + t_l^p$
- 7: **if**  $t_j^m \leq t_G^f$  **then**
- 8:   **for** each  $j \in l$  **do**
- 9:      $t_j^m \leftarrow t_G^f$
- 10:   **end for**
- 11:    $t_l^e \leftarrow t_G^f + t_l^{c*}$
- 12: **end if**

▷ Computation of time of entry for groups 2 to  $N$  in the optimal sequence

- 13: **for**  $k = 2$  to  $N$  **do**
- 14:    $r = \text{optimalSequence}[k]$
- 15:   **for** each  $j \in r$  **do**
- 16:      $t_j^m \leftarrow t_{r-1}^e$
- 17:   **end for**
- 18:    $t_r^e \leftarrow t + t_r^{c*}$
- 19:    $\text{lastG} = \text{optimalSequence}[N]$
- 20: **end for**
- 21:  $t_G^f \leftarrow t_{\text{lastG}}^e$

---

where  $t_l^0$  is time that the platoon leader enters the schedule zone, and  $t_l^m$  is time that the platoon leader enters the merging zone.

2) *Energy Optimal Control Problem:* For each leader  $l \in A_j$  of the platoon  $j \in \mathcal{N}(t)$ , we define the following optimal control problem

$$\min_{u_l \in \mathcal{U}_l} J_2(u_l(t)) = \frac{1}{2} \int_{t_l^0}^{t_l^m} u_l^2(t) dt, \quad (30)$$

subject to: (1), (2), (3),  $p_l(t_l^0) = 0$ ,  $p_l(t_l^m) = L_s$  and given  $t_l^0, v_l^0, t_l^m$ ,

where  $t_l^0$  time that platoon leader enters the schedule zone, and  $t_l^m$  is time that the platoon leader enters the merging zone.

### III. ANALYTICAL SOLUTION

In this section, we derive the closed-form analytical solutions for the time and energy optimal control problems for each platoon leader  $l \in A_j$ .

#### A. Analytical Solution of the Time Optimal Control Problem

We apply Hamiltonian analysis for deriving the analytical solution of the time optimal control problem. For each leader  $l \in A_j$ , the Hamiltonian function with the state and control

constraints is

$$\begin{aligned} H_l(t, p_l(t), v_l(t), u_l(t)) &= 1 + \lambda_l^p v_l(t) + \lambda_l^v u_l(t) \\ &+ \mu_l^a (u_l(t) - u_{\max}) + \mu_l^b (u_{\min} - u_l(t)) \\ &+ \mu_l^c (v_l(t) - v_{\max}) + \mu_l^d (v_{\min} - v_l(t)), \end{aligned} \quad (31)$$

where  $\lambda_l^p$  and  $\lambda_l^v$  are costates and  $\mu_l^a, \mu_l^b, \mu_l^c$ , and  $\mu_l^d$  are lagrange multipliers.

We consider that the state constraint (3) is not active, and therefore  $\mu_l^c$  and  $\mu_l^d = 0$ . Then,

$$\lambda_l^p = a_l, \quad (32)$$

$$\lambda_l^v = -a_l t + b. \quad (33)$$

From (31), the optimal control input is,

$$u_l^*(t) = \begin{cases} u_{\min}, & \lambda_l^v > 0, \\ u_{\max}, & \lambda_l^v < 0. \end{cases} \quad (34)$$

We consider two cases while platoons are entering the schedule zone of the intersection.

*Case 1:* If the platoon enters the schedule zone with  $v_l(t) \leq v_{\max}$ , then from (34) we have

$$u_l^*(t) = \begin{cases} u_{\max}, & \text{if } t_l^0 \leq t \leq t_l^0 + t_l^s, \\ 0, & \text{if } t_l^0 + t_l^s \leq t \leq t_l^m. \end{cases} \quad (35)$$

Substituting (35) in (1), we can compute the optimal position and velocity,

$$p_l^*(t) = \frac{1}{2} u_l t^2 + b_l t + c_l, \quad (36)$$

$$v_l^*(t) = u_l t + b_l, \quad t \in [t_l^0, t_l^0 + t_l^s], \quad (37)$$

$$p_l^*(t) = v_{\max} t + d_l, \quad (38)$$

$$v_l^*(t) = v_{\max}, \quad t \in [t_l^0 + t_l^s, t_l^m]. \quad (39)$$

where  $b_l, c_l$ , and  $d_l$  are integration constants. We can compute these constants using the initial and final conditions in (29).

*Case 2:* If the platoon enters the schedule zone with  $v_l(t) = v_{\max}$ , then from (34) we have

$$u_l^*(t) = 0, \quad t \in [t_l^0, t_l^m]. \quad (40)$$

Substituting (40) in (1), we can compute the optimal position and velocity,

$$p_l^*(t) = v_{\max} t + d_l, \quad (41)$$

$$v_l^*(t) = v_{\max}, \quad t \in [t_l^0, t_l^m]. \quad (42)$$

where  $d_l$  is integration constant. We can compute the constant using the initial and final conditions in (29). The complete solution of the optimal control problem with state and control constraints is presented in [41].

#### B. Analytical Solution of the Energy Optimal Control Problem

For the analytical solution of energy optimal control problem, we apply Hamiltonian analysis with inactive state and control



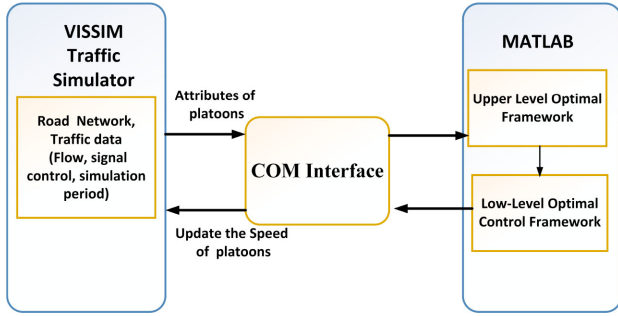

Fig. 4. Simulation framework in VISSIM-MATLAB environment.

constraints. We formulate the Hamiltonian function for each platoon leader  $l \in A(t)$  as follows

$$\begin{aligned}
 H_l(t, p_l(t), v_l(t), u_l(t)) = & \frac{1}{2}u_l^2(t) + \lambda_l^p v_l(t) + \lambda_l^v u_l(t) \\
 & + \mu_l^a (u_l(t) - u_{l,\max}) + \mu_l^b (u_{l,\min} - u_l(t)) \\
 & + \mu_l^c (v_l(t) - v_{l,\max}) + \mu_l^d (v_{l,\min} - v_l(t)), \quad (43)
 \end{aligned}$$

where  $\lambda_l^p$  and  $\lambda_l^v$  are costates, and  $\mu_l^a$ ,  $\mu_l^b$ ,  $\mu_l^c$ , and  $\mu_l^d$  are the lagrange multipliers. Since the control and state constraints are not active,  $\mu_l^a = \mu_l^b = \mu_l^c = \mu_l^d = 0$ . The optimal control input based on [15] will be

$$u_l^* = a_l t + b_l, \quad t \in [t_l^0, t_l^m]. \quad (44)$$

Substituting (44) in (1), we can find the optimal position and velocity,

$$p_l^* = \frac{1}{6}a_l t^3 + \frac{1}{2}b_l t^2 + c_l t + d_l, \quad t \in [t_l^0, t_l^m], \quad (45)$$

$$v_l^* = \frac{1}{2}a_l t^2 + b_l t + c_l, \quad t \in [t_l^0, t_l^m], \quad (46)$$

where  $a_l$ ,  $b_l$ ,  $c_l$ , and  $d_l$  are integration constants. We can compute these constants using initial and final conditions, i.e.,  $p_l(t_l^0) = p_l^0$ ,  $v_l(t_l^0) = v_l^0$ , and  $p_l(t_l^m) = p_l^m$ ,  $v_l(t_l^m) = v_l^m$ .

#### IV. SIMULATION FRAMEWORK AND RESULTS

We present the simulation framework (Fig. 4) using a VISSIM-MATLAB environment. In our simulation study, we model the intersection using VISSIM 11.00 traffic simulator [42]. The length of the schedule zone  $S$  and the merging zone  $M$  for the intersection is 200 m and 50 m, respectively. We designate platoons of varying sizes from 1 to 5 vehicles. The speed limit of road is 18 m/s. The maximum speed is set as 18 m/s for platoons going straight, 9 m/s for left turning and 7 m/s for right turning platoons. We set the maximum acceleration limit to be 3 m/s<sup>2</sup> and the minimum deceleration to be -3 m/s<sup>2</sup>. We implement the upper-level and the low-level optimal framework in MATLAB. In the upper-level, we collect the attributes of platoons including link number, lane number, path, current position, current speed, and number of following vehicles. Then, we compute the time of entry for each platoon into the merging zone. In the low-level, we derive the optimal control input and computes the speed of each platoon based on

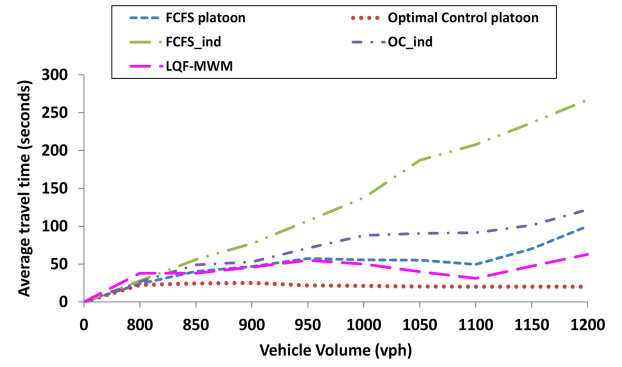

Fig. 5. Average travel time.

the time of entry provided by the upper-level framework. Then, the speed of the platoons is updated using COM interface in VISSIM traffic simulator in real-time.

The vehicles form platoons of varying sizes from 1 to 5 and are allowed to cross the intersection based on proposed optimal framework (denoted as OC\_Platoon). To validate the effectiveness of the proposed optimal framework, we performed a comparative study with four cases.

*Case 1:* The platoons of varying sizes from 1 to 5 are allowed to cross the intersection based on FCFS scheduling algorithm and this case is denoted as FCFS\_Platoon.

*Case 2:* The vehicles are not allowed to cross the intersection as platoons but they are allowed to cross the intersection one after the other as individual vehicles based on FCFS scheduling algorithm and this case is denoted as FCFS\_ind.

*Case 3:* The vehicles are not allowed to cross the intersection as platoons but they are allowed to cross the intersection one after the other based on proposed optimal control algorithm and this case is denoted as OC\_ind.

*Case 4:* The vehicles are given right of way at the intersection based on LQF-MWM scheduling algorithm [43]. Each lane approaching the intersection is assigned a weight based on their queue length. We group lanes of non-conflicting traffic movements as compatible lanes, i.e., vehicles in compatible lane group can be given right of way concurrently inside the intersection. For instance (Fig. 1), Lanes 2, 3, 5 & 6, Lanes 1 & 4, Lanes 8, 9, 10, & 11, and Lanes 7 & 12 are compatible lanes. The weights associated with each lane group is sum of queue lengths of each lane in the group. The weights are calculated for a time interval. In each time interval, the lane group with maximum weight is given right of way inside the intersection.

We ran the simulation for 900 seconds and collected the evaluation data to compare the performance of the proposed framework in terms of average travel time and fuel consumption with FCFS\_Platoon, LQF-MWM, FCFS\_ind and OC\_ind cases. The average travel time and fuel consumption for all the cases are shown in Figs. 5 and 6.

The position, velocity, and acceleration profiles of a platoon from the time of entry inside the scheduling zone to the time at which it exits the merging zone is shown in Fig. 7. The position profile of the platoon indicates that the platoons enter the merging zone at the time of entry provided by the upper-level

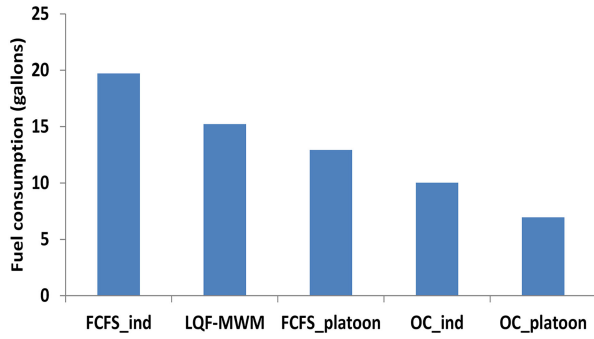

Fig. 6. Fuel consumption for each case.

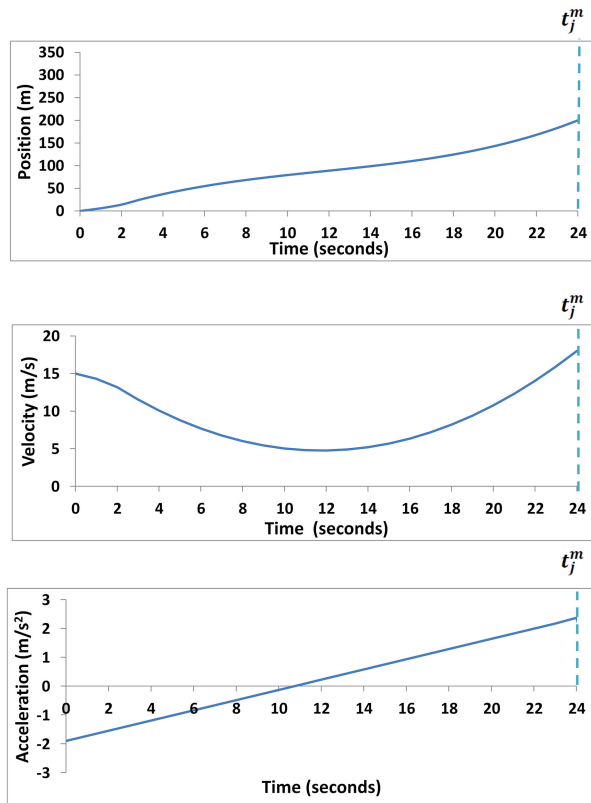

Fig. 7. Position, velocity, and acceleration profile of a platoon.

optimization framework. The speed profile of the platoon shows that the platoon updates the speed based on their optimal control input (acceleration/deceleration) and exits the merging zone without stopping at the intersection. In case of increasing traffic flow, few platoons stop and wait for the previously entered platoons in the schedule zone to exit the intersection. Then, the platoons find the optimal speed to exit the intersection.

The comparison of performance measures of vehicles under OC\_Platoon, FCFS\_Platoon, LQF-MWM, OC\_Ind and FCFS\_ind cases are summarized in Tables I and II. The OC\_ind case reduced the average travel time by 46.89% and fuel consumption by 49.1% over FCFS\_Ind case. The FCFS\_platoon case reduced the average travel time by 61.74% and fuel consumption by 52.5% over FCFS\_Ind case. The LQF-MWM algorithm reduced the average travel time by 68.71% and fuel

TABLE I  
COMPARISON OF PERFORMANCE MEASURES OF VEHICLES UNDER DIFFERENT CASES WITH OC\_PLATOON CASE

Cases	Average Travel Time (sec)	Average Delay per Vehicle (sec/Veh)	Fuel Consumption (gallons)
FCFS_Platoon	-60.6%	-98.94%	-46.24%
LQF-MWM	-51.99%	-98.91%	-54.36%
OC_Ind	-71.68%	-99.1%	-30.72%
FCFS_Ind	-84.96%	-99.1%	-64.76%

TABLE II  
COMPARISON OF PERFORMANCE MEASURES OF VEHICLES UNDER DIFFERENT CASES WITH FCFS\_IND CASE

Cases	Average Travel Time (sec)	Average Delay per Vehicle (sec/Veh)	Fuel Consumption (gallons)
OC_Ind	-46.89%	-45.89%	-49.1%
FCFS_Platoon	-61.74%	-81.94%	-52.5%
LQF-MWM	-68.71%	-83.83%	-22.79%
OC_Platoon	-84.96%	-98.1%	-64.76%

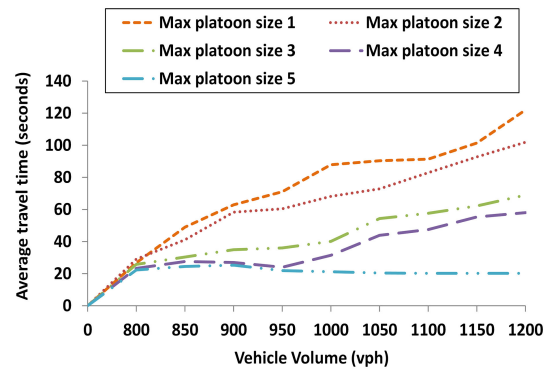

Fig. 8. Average travel time of vehicles.

consumption by 22.79% over FCFS\_Ind case. The LQF-MWM algorithm resulted in high fuel consumption since vehicles are completely stopped at stop line and given right of way based on the queue length of compatible lane groups. The OC\_platoon case reduced the average travel time by 84.96% and fuel consumption by 64.76% over FCFS\_Ind case.

We perform a simulation study to evaluate the effect of platooning while crossing the intersection. We consider five cases where the vehicles are allowed to form platoons of maximum size 1, 2, 3, 4, and 5, respectively and allowed to cross the intersection based on proposed optimal control algorithm. The average travel time and fuel consumption for all the cases of varying platoon sizes are shown in Figs. 8 and 9. The scenario in which the vehicles are allowed to form platoon of maximum size 2 reduced the average travel time by 13.56% and fuel consumption by 9.05% when compared with scenario in which the maximum platoon size is 1. The scenario in which the vehicles are allowed to form platoon of maximum size 3 reduced the average travel time by 41.61% and fuel consumption by 20.6% when compared with scenario in which platoon size is 1. The scenario in which the vehicles are allowed to form platoon of maximum size 4 reduced the average travel time by 51.9% and

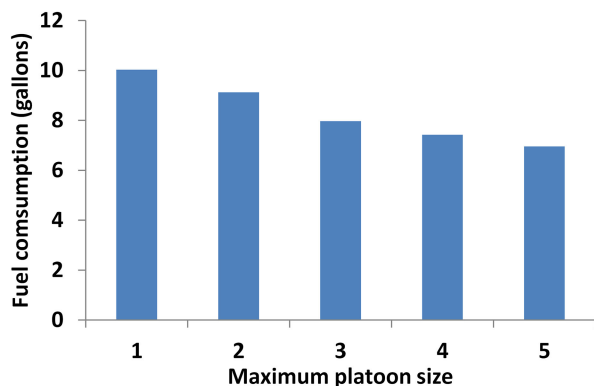

Fig. 9. Fuel consumption of vehicles in the network.

fuel consumption by 26.03% when compared with scenario in which platoon size is 1. The scenario in which the vehicles are allowed to form platoon of maximum size 5 reduced the average travel time by 71.68% and fuel consumption by 30.72% when compared with scenario in which platoon size is 1.

## V. CONCLUSION

In this paper, we investigated the problem of optimal coordination of platoons of CAVs at a signal-free intersection. We developed a decentralized, two-level optimal framework for coordinating the platoons with the objective to minimize travel delay and fuel consumption. In the upper level, we presented an optimization framework to reduce the delay of the platoons at an intersection. In the low level, we presented a time and energy optimal control problem, and derived analytical solutions that provided optimal control input to the platoons. We performed a comparative study of the proposed framework with the FCFS and LQF-MWM scheduling algorithms. The simulation analysis showed that the proposed framework significantly reduces the travel time and fuel consumption of the platoons at the intersection. We also investigated the effect of platooning by considering platoons of varying sizes while crossing the intersection.

Ongoing efforts consider lane changes of platoons at an intersection. The proposed approach assumes that vehicles form platoons before entering the schedule zone and restricts the vehicle from one platoon to join other platoon inside the schedule zone. Future research should consider the formation of platoons inside the schedule zone along with stability of the platoons, and extend the proposed framework for a mixed environment of human-driven vehicles and CAVs at different penetration rates.

## ACKNOWLEDGMENT

The authors would like to thank B. Chalaki, A M Ishtiaque Mahbub and L. E. Beaver for the technical discussions.

## REFERENCES

- [1] IEA, "Policy pathways: A tale of renewed cities," *Org. Econ.*, Paris, France, vol. 00003, pp. 1–98, 2013.
- [2] T. Reed, "Inrix global traffic scorecard," 2019. [online]. Available: [https://static.poder360.com.br/2019/02/INRIX\\_2018\\_Global\\_Traffic\\_Scorecard\\_Report\\_final\\_.pdf](https://static.poder360.com.br/2019/02/INRIX_2018_Global_Traffic_Scorecard_Report_final_.pdf)
- [3] J. Rios-Torres and A. A. Malikopoulos, "A survey on the coordination of connected and automated vehicles at intersections and merging at highway on-ramps," *IEEE Trans. Intell. Transp. Syst.*, vol. 18, no. 5, pp. 1066–1077, May 2017.
- [4] L. Zhao and A. A. Malikopoulos, "Enhanced mobility with connectivity and automation: A review of shared autonomous vehicle systems," *IEEE Intell. Transp. Syst. Mag.*, vol. 14, no. 1, pp. 87–102, Jan.-Feb. 2022.
- [5] K. Dresner and P. Stone, "A multiagent approach to autonomous intersection management," *J. Artif. Intell. Res.*, vol. 31, pp. 591–656, 2008.
- [6] S. Huang, A. W. Sadek, and Y. Zhao, "Assessing the mobility and environmental benefits of reservation-based intelligent intersections using an integrated simulator," *IEEE Trans. Intell. Transp. Syst.*, vol. 13, no. 3, pp. 1201–1214, Sep. 2012.
- [7] J. Lee and B. Park, "Development and evaluation of a cooperative vehicle intersection control algorithm under the connected vehicles environment," *IEEE Trans. Intell. Transp. Syst.*, vol. 13, no. 1, pp. 81–90, Mar. 2012.
- [8] J. Wu, F. Perronnet, and A. Abbas-Turki, "Cooperative vehicle-actuator system: A sequence-based framework of cooperative intersections management," *IET Intell. Transport Syst.*, vol. 8, no. 4, pp. 352–360, 2013.
- [9] J. Rios-Torres and A. A. Malikopoulos, "Automated and cooperative vehicle merging at highway on-ramps," *IEEE Trans. Intell. Transp. Syst.*, vol. 18, no. 4, pp. 780–789, Apr. 2017.
- [10] X. Qian, F. Altché, J. Grégoire, and A. de La Fortelle, "Autonomous intersection management systems: Criteria, implementation and evaluation," *IET Intell. Transport Syst.*, vol. 11, no. 3, pp. 182–189, 2017.
- [11] P. Lin, J. Liu, P. J. Jin, and B. Ran, "Autonomous vehicle-intersection coordination method in a connected vehicle environment," *IEEE Intell. Transp. Syst. Mag.*, vol. 9, no. 4, pp. 37–47, winter 2017.
- [12] J. Rios-Torres and A. A. Malikopoulos, "Impact of partial penetrations of connected and automated vehicles on fuel consumption and traffic flow," *IEEE Trans. Intell. Veh.*, vol. 3, no. 4, pp. 453–462, Dec. 2018.
- [13] F. Hart, M. Saraoglu, A. Morozov, and K. Janschek, "Fail-safe priority-based approach for autonomous intersection management," *IFAC-PapersOnLine*, vol. 52, no. 8, pp. 233–238, 2019.
- [14] W. Wu, J. Zhang, A. Luo, and J. Cao, "Distributed mutual exclusion algorithms for intersection traffic control," *IEEE Trans. Parallel Distrib. Syst.*, vol. 26, no. 1, pp. 65–74, Jan. 2015.
- [15] A. A. Malikopoulos, C. G. Cassandras, and Y. J. Zhang, "A decentralized energy-optimal control framework for connected automated vehicles at signal-free intersections," *Automatica*, vol. 93, pp. 244–256, 2018.
- [16] A. A. Malikopoulos and L. Zhao, "Optimal path planning for connected and automated vehicles at urban intersections," in *Proc. 58th IEEE Conf. Decis. Control*, 2019, pp. 1261–1266.
- [17] A. A. Malikopoulos, L. E. Beaver, and I. V. Chremos, "Optimal time trajectory and coordination for connected and automated vehicles," *Automatica*, vol. 125, 2021, Art. no. 109469.
- [18] L. Zhao and A. A. Malikopoulos, "Decentralized optimal control of connected and automated vehicles in a corridor," in *Proc. 21st Int. Conf. Intell. Transp. Syst.*, 2018, pp. 1252–1257.
- [19] J. Lioris, R. Pedarsani, F. Y. Tascikaraoglu, and P. Varaiya, "Platoons of connected vehicles can double throughput in urban roads," *Transp. Res. Part C: Emerg. Technol.*, vol. 77, pp. 292–305, 2017.
- [20] C. Bergenhem, S. Shladover, E. Coelingh, C. Englund, and S. Tsugawa, "Overview of platooning systems," in *Proc. 19th ITS World Congr.*, Oct. 22–26, Vienna, Austria (2012), 2012, pp. 1–8.
- [21] Q. Jin, G. Wu, K. Boriboonsomsin, and M. Barth, "Platoon-based multi-agent intersection management for connected vehicle," in *Proc. 16th Int. IEEE Conf. Intell. Transp. Syst.*, 2013, pp. 1462–1467.
- [22] P. Tallapragada and J. Cortés, "Coordinated intersection traffic management," *IFAC-PapersOnLine*, vol. 48, no. 22, pp. 233–239, 2015.
- [23] J. J. B. Vial, W. E. Devanny, D. Eppstein, and M. T. Goodrich, "Scheduling autonomous vehicle platoons through an unregulated intersection," 2016 *arXiv:1609.04512*, .
- [24] M. Bashiri and C. H. Fleming, "A platoon-based intersection management system for autonomous vehicles," in *Proc. IEEE Intell. Veh. Symp.*, 2017, pp. 667–672.
- [25] M. Bashiri, H. Jafarzadeh, and C. H. Fleming, "Paim: Platoon-based autonomous intersection management," in *Proc. 21st Int. Conf. Intell. Transp. Syst.*, 2018, pp. 374–380.
- [26] W. Du, A. Abbas-Turki, A. Koukam, S. Galland, and F. Gechter, "On the v2x speed synchronization at intersections: Rule based system for extended virtual platooning," *Procedia Comput. Sci.*, vol. 141, pp. 255–262, 2018.
- [27] M. Di Vaio, P. Falcone, R. Hult, A. Petrillo, A. Salvi, and S. Santini, "Design and experimental validation of a distributed interaction protocol for connected autonomous vehicles at a road intersection," *IEEE Trans. Veh. Technol.*, vol. 68, no. 10, pp. 9451–9465, Oct. 2019.

- [28] D. Miculescu and S. Karaman, "Polling-systems-based autonomous vehicle coordination in traffic intersections with no traffic signals," *IEEE Trans. Autom. Control*, vol. 65, no. 2, pp. 680–694, Feb. 2020.
- [29] Y. Feng, D. He, and Y. Guan, "Composite platoon trajectory planning strategy for intersection throughput maximization," *IEEE Trans. Veh. Technol.*, vol. 68, no. 7, pp. 6305–6319, Jul. 2019.
- [30] A. Giridhar and P. Kumar, "Scheduling automated traffic on a network of roads," *IEEE Trans. Veh. Technol.*, vol. 55, no. 5, pp. 1467–1474, Sep. 2006.
- [31] L. Li and F.-Y. Wang, "Cooperative driving at blind crossings using intervehicle communication," *IEEE Trans. Veh. Technol.*, vol. 55, no. 6, pp. 1712–1724, Nov. 2006.
- [32] J. Wu, A. Abbas-Turki, and A. E. Moudni, "Intersection traffic control by a novel scheduling model," in *Proc. IEEE/INFORMS Int. Conf. Serv. Operations, Logistics Inform.*, 2009, pp. 329–334.
- [33] F. Yan, M. Dridi, and A. Moudni, "A scheduling approach for autonomous vehicle sequencing problem at multi-intersections," *Int. J. Operations Res.*, vol. 9, no. 1, pp. 57–68, 2011.
- [34] A. Colombo and D. Del Vecchio, "Least restrictive supervisors for intersection collision avoidance: A scheduling approach," *IEEE Trans. Autom. Control*, vol. 60, no. 6, pp. 1515–1527, Jun. 2015.
- [35] H. Ahn and D. Del Vecchio, "Semi-autonomous intersection collision avoidance through job-shop scheduling," in *Proc. 19th Int. Conf. Hybrid Syst.: Comput. Control*, 2016, pp. 185–194.
- [36] B. Chalaki and A. A. Malikopoulos, "An optimal coordination framework for connected and automated vehicles in two interconnected intersections," in *Proc. IEEE Conf. Control Technol. Appl.*, 2019, pp. 888–893.
- [37] M. C. Lucas-Estañ *et al.*, "On the scalability of the 5G RAN to support advanced V2X services," in *Proc. IEEE Veh. Netw. Conf.*, 2020, pp. 1–4.
- [38] W. Levine and M. Athans, "On the optimal error regulation of a string of moving vehicles," *IEEE Trans. Autom. Control*, vol. 11, no. 3, pp. 355–361, Jul. 1966.
- [39] A. Aashto, "Policy on geometric design of highways and streets," *Amer. Assoc. State Highway Transp. Officials, Washington, DC*, vol. 1, no. 990, pp. 158–195, 2001.
- [40] J. R. Jackson, "Scheduling a production line to minimize maximum tardiness," *Manage. Sci. Res. Project*, Univ. California, Los Angeles, 1955.
- [41] B. Chalaki and A. A. Malikopoulos, "Time-optimal coordination for connected and automated vehicles at adjacent intersections," 2020, *arXiv:1911.04082*.
- [42] A. G. PTV, VISSIM 11 User Manual, PTV Group, Karlsruhe, Germany.
- [43] S. T. Maguluri, B. Hajek, and R. Srikant, "The stability of longest-queue-first scheduling with variable packet sizes," *IEEE Trans. Autom. Control*, vol. 59, no. 8, pp. 2295–2300, Aug. 2014.



USA. Her research interests include intelligent transportation systems, control engineering, and graph theory.

**Sharmila Devi Kumaravel** (Student Member, IEEE) received the B.E degree in electronics and instrumentation engineering from Bharathidasan University, Trichy, India, in 2004 and the M.E. degree in power electronics and drives from Anna University, Chennai, India, in 2008. She is currently working toward the Ph.D. degree with the Department of Instrumentation and Control Engineering, National Institute of Technology, Tiruchirappalli, India. She was a Visiting Research Scholar with the Department of Mechanical Engineering, University of Delaware, Newark, DE,



**Andreas A. Malikopoulos** (Senior Member, IEEE) received the Diploma in mechanical engineering from the National Technical University of Athens, Athens, Greece, in 2000, and the M.S. and Ph.D. degrees from the Department of Mechanical Engineering, University of Michigan, Ann Arbor, MI, USA, in 2004 and 2008, respectively. He is the Terri Connor Kelly and John Kelly Career Development Associate Professor with the Department of Mechanical Engineering, University of Delaware (UD), Newark, DE, USA, the Director of the Information and Decision

Science (IDS) Laboratory, and the Director of the Sociotechnical Systems Center. Before he joined UD, he was the Deputy Director and the Lead of the Sustainable Mobility Theme of the Urban Dynamics Institute, Oak Ridge National Laboratory, Oak Ridge, TN, USA, and a Senior Researcher with General Motors Global Research & Development. His research interests include analysis, optimization, and control of cyber-physical systems; decentralized systems, stochastic scheduling and resource allocation problems, and learning in complex systems. The emphasis is on applications related to smart cities, emerging mobility systems, and sociotechnical systems. From 2017 to 2020, he was an Associate Editor for the IEEE TRANSACTIONS ON INTELLIGENT VEHICLES and IEEE TRANSACTIONS ON INTELLIGENT TRANSPORTATION SYSTEMS. He is currently an Associate Editor for the *Automatica* and IEEE TRANSACTIONS ON AUTOMATIC CONTROL. He is a member of SIAM, AAAS, and a Fellow of the ASME.



Indian NMO of the IFAC, through which he passionately contributes to controls education in India.

**Ramakalyan Ayyagari** (Senior Member, IEEE) is currently a Professor with the Instrumentation & Control Engineering Department, National Institute of Technology, Tiruchirappalli, India. He is deeply interested in looking into computational problems that arise out of the algebra and graphs in control theory and applications. His particular interest include the NP-hard problems and the Randomized Algorithms. He is a member of SIAM. He was the Founding Secretary and Past President of Automatic Control and Dynamic Optimization Society (ACDOS), the